

E SERIES CATALOG

Fixed Window and Storm Window Lineals and Components

Corporate Office

123 Oxmoor Road West • Birmingham, AL 35209
P.O. Box 59226 • Birmingham, AL 35259-9226
Tel ephone: 1/800/868-4100
Fax: (205) 945-4399

Mason-Dallas • 2080 McDaniel, Ste. 125
Carrollton, TX 75006
Tel ephone: 1/800/756-2766 • Fax: (972) 247-7656

Mason-Kansas City • 1912 East 19th Street
Kansas City, MO 64127
Tel ephone: 1/800/925-0291 • Fax: (816) 241-7314

Mason-Raleigh • 1601 Lake Wheeler Road
Raleigh, NC 27603
Tel ephone: 1/800/476-2593 • Fax: (919) 836-1944

Mason-Knoxville • 4610 Coster Road
Knoxville, TN 37912
Tel ephone: 1/800/961-6266 • Fax: (865) 687-3841

Mason-Little Rock • 700 North Palm
North Little Rock, AR 72114
Tel ephone: 1/800/611-5162 • Fax: (501) 955-2147

Mason-Columbia • 4B Sunbelt Court
Columbia, SC 29203
Tel ephone: 1/866/649-3009 • Fax: (803) 461-6072



FIXED WINDOW AND STORM WINDOW LINEALS AND COMPONENTS

MAIN FRAME FOR PICTURE WINDOW

E100 Dark Bronze .055" extruded aluminum
 White
 Anodized

Standard Package: 30 pcs. 16' length
 Use F653B glazing bead for 1/8" glass and F654B for 3/16",
 7/32" and 1/4" glass.
 Use T760A drill jig.

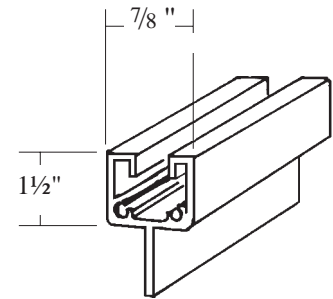

MAIN FRAME HEAD AND SILL

E107 Bronze .045" extruded aluminum
 Mill
 Ivory
 White

Standard Package: (480') 30 pcs. 16' length
 For aluminum prime and blind stop window installation.
 Offset style.
 Use E803 corner screws.

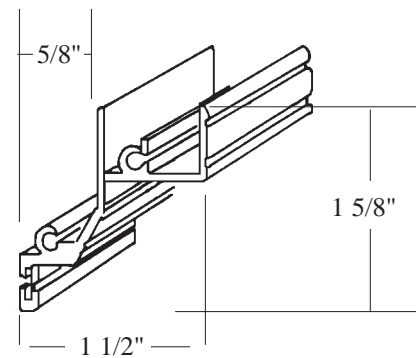

MAIN FRAME JAMB

E108 Bronze .045" extruded aluminum
 Mill
 Ivory
 White

Standard Package: (480') 30 pcs. 16' length
 For aluminum prime and blind stop window installation.
 Offset style.

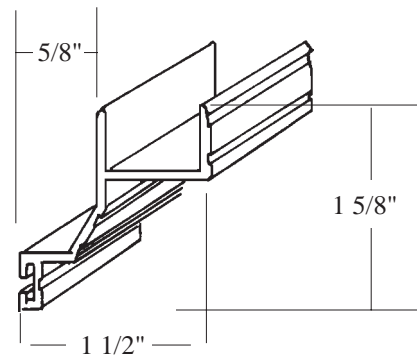

MAIN FRAME HEAD AND SILL

E113 Bronze .045" extruded aluminum
 Mill
 White

Standard Package: (480') 30 pcs. 16' length
 For blind stop OR OVERLAP window installation.
 Use E803 corner screws.

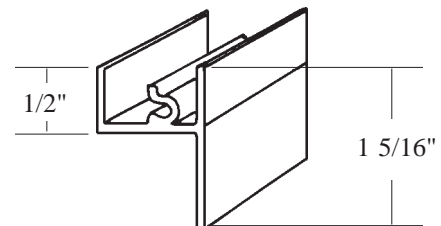

FIXED WINDOW AND STORM WINDOW LINEALS AND COMPONENTS

MAINFRAME JAMB

E114 Bronze .045" extruded aluminum
 Mill
 White

Standard Package: (480') 30 pcs. 16' length
For blind stop or overlap installation.

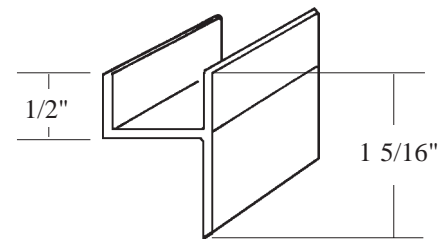

GLASS MOLD, E-Z GLAZE

E210 Mill Finish .024" roll formed aluminum
 Dark Bronze
 White

Standard Package: (525') 42 pcs. 12'6" length
For single or double strength glass. Use E606 glazing bead and E709 corner inserts. For single strength glass use E651 bedding tape.

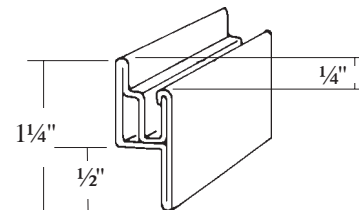

GLASS MOLD WITH VINYL WEATHERSTRIP

E224 Mill Finish .024" roll formed aluminum
 Ivory
 Bronze
 White

Standard Package: (1,008') 84 pcs. 12' length
*For single or double strength glass.
 Use E704 corner inserts and E702 corner clips.*

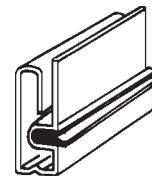

GLASS MOLD WITH PILE WEATHERSTRIP

E301 Bronze .020" roll formed aluminum
 Mill
 White

Standard Package: (1,050') 84 pcs. 12'6" length
 (1,344') 84 pcs. 16' length

*For single or double strength glass.
 Use E704 corner inserts and E702 corner clips.*

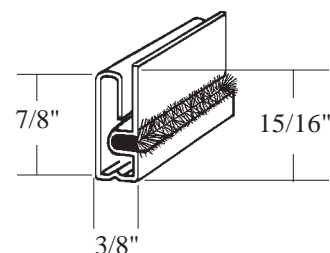

MASON CORPORATION
 123 Oxmoor Road, West
 Birmingham, AL 35209-6302

Telephone: 1/800/868-4100
 Fax: 205/945-4399

FIXED WINDOW AND STORM WINDOW LINEALS AND COMPONENTS

GLAZING BEAD

F653 Black Vinyl, wrap around

Standard Package: 500' roll
 For 1/8" glass.



GLAZING BEAD

F654 Black Vinyl, wrap around

Standard Package: 500' roll
 For 3/16", 7/32", and 1/4" glass.



GLAZING BEAD

E606 Black Vinyl

Standard Package: 500' roll
 Drop-in type. Use to glaze E210
 E-Z Glaze glass mold.

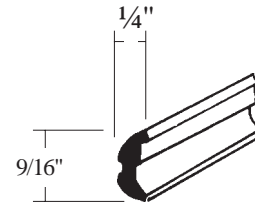

WEATHERSTRIPPING

E645 Black Vinyl
 Clay
 White
 Ivory

Standard Package: 1,000' roll
 Bulb type. Used for Panorama and Clearview enclosures.

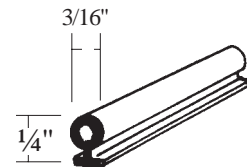

TITE-PAK TAPE

E651 1/4" wide

Standard Package: 150' roll
 Pressure sensitive back. Use as glass bedding
 on E210 glass mold.

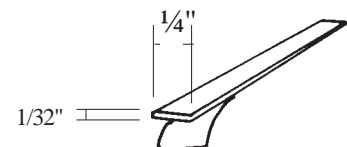

FIXED WINDOW AND STORM WINDOW LINEALS AND COMPONENTS

THERMAL ISOLATOR BEAD

E678 Black

Standard Package: 500' roll

Use to weatherstrip and insulate between storm window and metal prime windows.

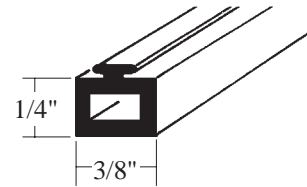

CORNER LATCH, LONG NOSE

E540 Black Zinc die cast

Standard Package: 100 sets (1 right and 1 left)

*Use with E224 and L162 glass molds.
(Thumb screws not included.)*

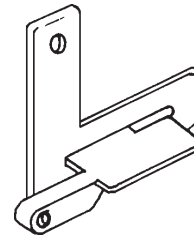

ANGLE

E680 Dark Bronze .050" extruded aluminum
White

Standard Length: 12'
Standard Package: As required

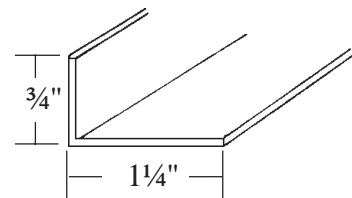

ALL PURPOSE ANGLE

E700 Mill Finish .125 extruded aluminum,

Standard Length: 12'
Standard Package: As required

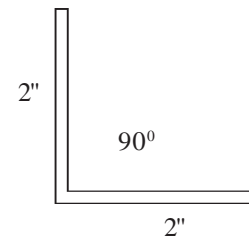

EXTRUDED ALUMINUM MULLION

E773 Bronze
Mill
Ivory
White

Standard Package: (800') 50 pcs. 16' length

Use at meeting rails of all self storing storm windows and doors.

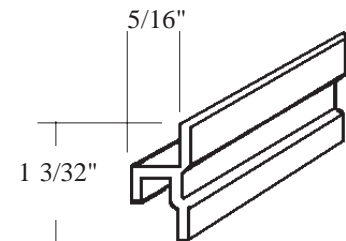

FIXED WINDOW AND STORM WINDOW LINEALS AND COMPONENTS

WIRE CORNER CLIP

E702 Mill Finish

Standard Package: 100 sets (8 clips per set)
To fasten corners of roll formed E224 and L162 glass molds.



CORNER INSERT

E704 Mill Finish .090" stamped aluminum

Standard Package: 100 sets (4 per set)
Use in roll formed E224, E301 and L162 glass molds.

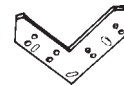

CORNERINSERT

E709 Mill Finish 1/8" stamped aluminum

Standard Package: 100 sets (4 per set)
For E210 E-Z Glaze glass mold.



THUMB SCREW, DELRIN

E406 Black

Standard Package: 200 each
Use with E540 corner latch.



CORNER SCREW

E803 Mill Finish #8-18 x 1" , #410 st. steel
 Bronze
 Ivory
 White

Standard Package: 100 each
*Round head, square recess, 1/4" lead point,
 brite hardened, passivated and waxed.*



MASON CORPORATION
 123 Oxmoor Road, West
 Birmingham, AL 35209-6302

Telephone: 1/800/868-4100
 Fax: 205/945-4399

FIXED WINDOW AND STORM WINDOW LINEALS AND COMPONENTS

SHEET METAL SCREW

E808 Mill Finish #8-18 x 9/16", #410 st. steel
 Bronze
 Ivory
 White

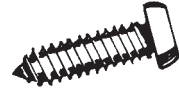

Standard Package: 500 each
Square socket pan head, type AB, brite hardened.

INSTALLATION SCREW

E809 Mill Finish #8-18 x 3/4", #410 st. steel
 Bronze sheet metal screw.
 Ivory
 White

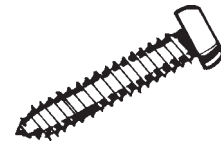

Standard Package: 100 each
Square socket pan head, type AB, brite hardened.

PIANO HINGE

E003 .050" aluminum with 1½" flanges

 Continuous piano type hinge. 72" holes on 6" centers

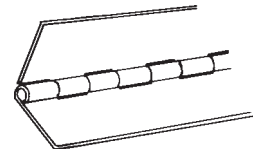

ACRY-LAR SEAM SEALER

E006 Bronze
 Mill
 White

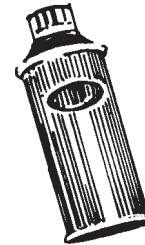

Standard Package: 16 oz. cans



MASON CORPORATION
 123 Oxmoor Road, West
 Birmingham, AL 35209-6302

Telephone: 1/800/868-4100
 Fax: 205/945-4399