

SCREEN FRAME - LINEALS & COMPONENTS

SCREEN FRAME HANGERS

C511 Dark Bronze Stamped Aluminum
 Ivory
 Mill Finish
 White

C512 Dark Bronze Stamped Aluminum
 Ivory
 Mill Finish
 White

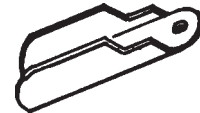

STANDARD PACKAGE: 200 each

*Use C511 with 3/8" screen frame.
 Use C512 with 7/16" screen frame.*

GUIDE CHANNEL

C605 Mill Finish .019" aluminum

STANDARD PACKAGE: (252') 21 pcs. 12' length
 (1,008') 84 pcs. 12' length

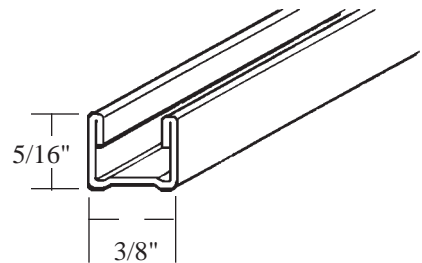

For 3/8" screen frame.

GUIDE CHANNEL

C608 Mill Finish .019" aluminum
 White
 Dark Bronze available in standard package
 of 1,008' only. Lead time required.

STANDARD PACKAGE: (252') 21 pcs. 12' length
 (1,008') 84 pcs. 12' length

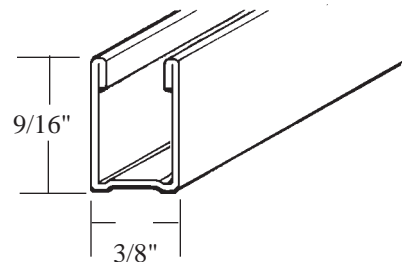

For 3/8" screen frame.



MASON CORPORATION
 123 Oxmoor Road, West
 Birmingham, AL 35209-6302

Telephone: 1/800/763-4488
 Fax: 205/945-4304

SCREEN FRAME - LINEALS & COMPONENTS

GUIDE CHANNEL

C611 Mill Finish .019" aluminum

STANDARD PACKAGE: (252') 21 pcs. 12' length

For 3/8" screen frame.

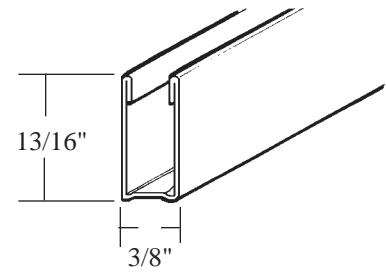

GUIDE CHANNEL

C620 Mill Finish .024" aluminum

STANDARD PACKAGE: (252') 21 pcs. 12' length
(1,008') 84 pcs. 12' length

For 7/16" screen frame.

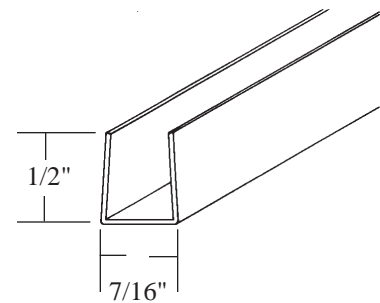

GUIDE CHANNEL

C629 Mill Finish .024" aluminum

STANDARD PACKAGE: (252') 21 pcs. 12' length
(1,008') 84 pcs. 12' length

For 7/16" screen frame.

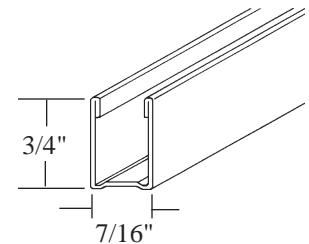

ALL PURPOSE ANGLE

C704 Mill Finish .024" aluminum

STANDARD PACKAGE: (252') 21 pcs. 12' length
(1,008') 84 pcs. 12' length

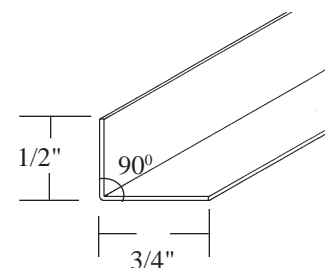

MASON CORPORATION
123 Oxmoor Road, West
Birmingham, AL 35209-6302

Telephone: 1/800/763-4488
Fax: 205/945-4304

SCREEN FRAME - LINEALS & COMPONENTS

BALL HEAD SCREW

C804 Mill Finish Aluminum, 1" long drive threads

STANDARD PACKAGE: 200 per package.

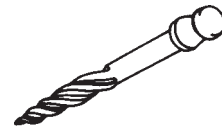

NAIL

C852 Electro-galvanized 3/16" head x 3/4" length

STANDARD PACKAGE: 1 lb.

Use to install friction hanger.

Use T412, T413, T414 Nail Set tool.



SCREEN LIFT

C900 0000 Black Nylon

C900 0001 Black Nylon

STANDARD PACKAGE: 500 per package

Inserts in spline groove and is secured by spline.

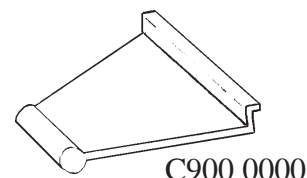

C900 0000

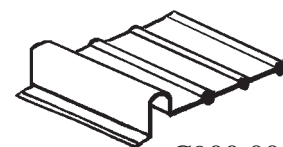

C900 0001

SLIDE LATCH

C901 Mill Finish .040" stamped aluminum

STANDARD PACKAGE: 200 each.

For box type screen frame under 3/4".

Use T600A with T609 blade.

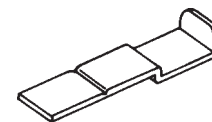

C902 Mill Finish .040" stamped aluminum

STANDARD PACKAGE: 200 each.

For box type screen frame for 3/4" only.

Use T600A with T609 blade.

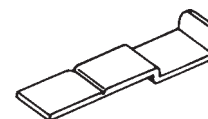

MASON CORPORATION
123 Oxmoor Road, West
Birmingham, AL 35209-6302

Telephone: 1/800/763-4488
Fax: 205/945-4304

SCREEN FRAME - LINEALS & COMPONENTS

RAM'S HORN CLIP

C903 Mill Finish

STANDARD PACKAGE: 1,000 per package

Use T600A with T608 blade.



KNIFE LATCH

C909 Mill Finish .040" stamped aluminum

STANDARD PACKAGE: 100 sets (1 RH & 1 LH per set)

For box type screen frame.

Use T600A with T608 blade.

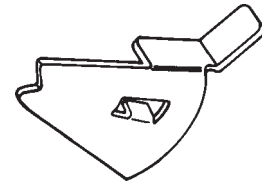

LATCH LIFT

C919 Mill Finish

STANDARD PACKAGE: 200 each.

Apply in spline groove of any screen frame .024" or under.

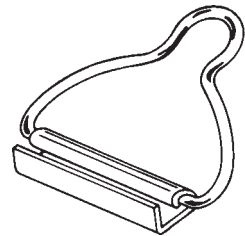

LATCH LIFT

C923 Mill Finish

For 3/8" screen frame.

C927 Mill Finish

For 7/16" screen frame.

STANDARD PACKAGE: 200 each.

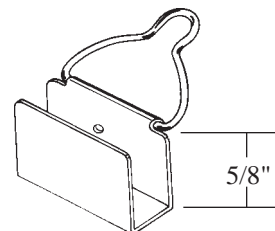

SCREEN FRAME - LINEALS & COMPONENTS

LATCH LIFT

C929 Mill Finish Highback style

For 7/16" screen frame.

C931 Mill Finish Highback style

For 3/8" screen frame.

STANDARD PACKAGE: 200 each.

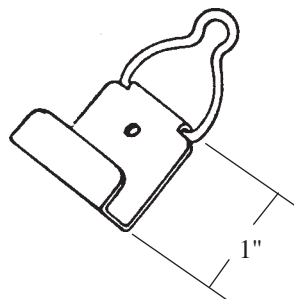

NYLON SPRING BOLT LATCH

C950 Black

STANDARD PACKAGE: 100 per package

Use T357A stepdown drill bit.

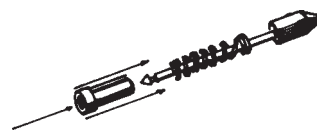

HOOK AND EYE ASSEMBLY

C955 Mill (Zinc plated) 1 1/4" with 8-32 threads

STANDARD PACKAGE: 100 per package

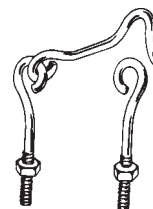

CASEMENT CLIP

C960 Mill Finish .050" stamped aluminum

STANDARD PACKAGE: 100 per package

Use to install 3/8" screens on casement windows.

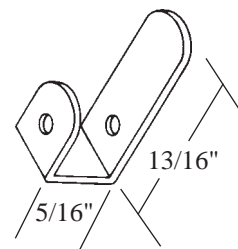

CASEMENT CLIP, FLUSH

C961 Mill(Zinc cast)

STANDARD PACKAGE: 100 per package

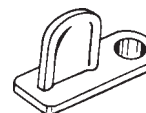

MASON CORPORATION
123 Oxmoor Road, West
Birmingham, AL 35209-6302

Telephone: 1/800/763-4488
Fax: 205/945-4304

SCREEN FRAME - LINEALS & COMPONENTS

CASEMENT CLIP

C962 Mill (Zinc cast) 3/16" offset for 1/4" frame

C963 Mill (Zinc cast) 3/8" offset for 7/16" frame

C964 Mill (Zinc cast) 7/16" offset for 1/2" frame

STANDARD PACKAGE: 100 per package

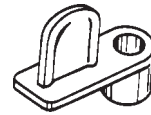

DIMPLE CLIP

C972 Mill Finish .063" Stamped aluminum

STANDARD PACKAGE: 100 per package

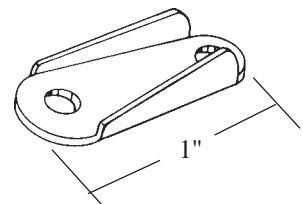

STRETCHER CLIP

C977 Mill Finish .063" aluminum

STANDARD PACKAGE: 100 per package

Use with C140 jalousie frame. Use E808A screw.

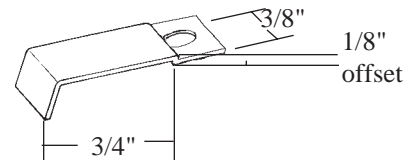

STRETCHER CLIP

C978 Mill Finish .063" aluminum

STANDARD PACKAGE: 100 per package

Use with C142 jalousie frame. Use E808A screw.

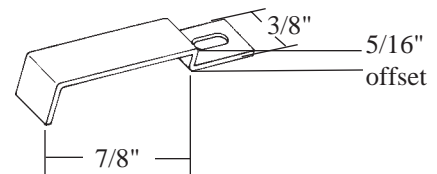

STRETCHER CLIP

C979 Mill Finish .050" aluminum

STANDARD PACKAGE: 100 per package

Use with C136A screen frame. Use E808A screw.

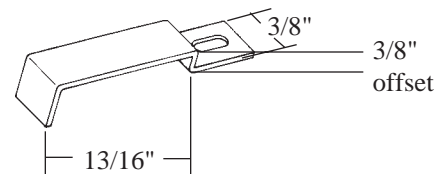

MASON CORPORATION
123 Oxmoor Road, West
Birmingham, AL 35209-6302

Telephone: 1/800/763-4488
Fax: 205/945-4304

SCREEN FRAME - LINEALS & COMPONENTS

DECORATOR STRIP

C001 Dark Bronze (.030" only) .040" aluminum
Mill Finish
White

STANDARD PACKAGE: (1,200') 100 pcs. 12" length

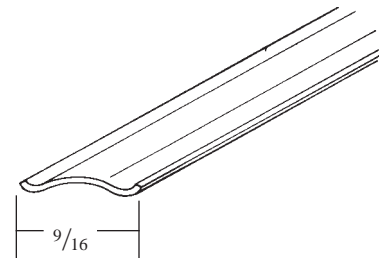

SCREEN RETAINER SPRING

C002 Mill Finish

STANDARD PACKAGE: 1,000 per package

Use T600A lancing tool with T599 blade.

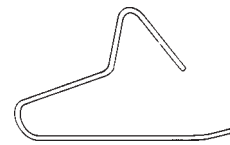

SIDE SPRING

C003 Mill Finish Zinc-plated steel

STANDARD PACKAGE: 100 per package

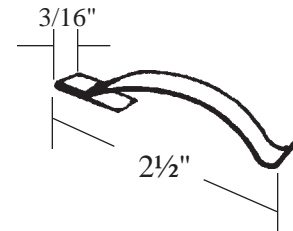

CENTER BAR CLIP

C004 Mill Finish

STANDARD PACKAGE: 200 each.

Use with C279 and C280 center bar.

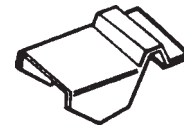

3" SPRING

C005 Mill Finish

STANDARD PACKAGE: 100 per package

*Use with C136, C137 and C138 screen frame.
Use T707A drill jig.*

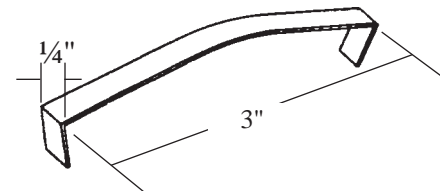

MASON CORPORATION
123 Oxmoor Road, West
Birmingham, AL 35209-6302

Telephone: 1/800/763-4488
Fax: 205/945-4304

SCREEN FRAME - LINEALS & COMPONENTS

3/4" SPRING

C006 Mill Finish

STANDARD PACKAGE: 100 per package

Use with C136 and C138 screen frame.

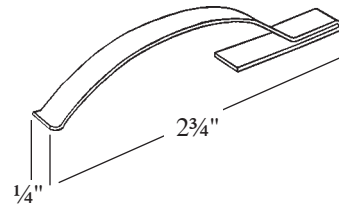

CENTER BAR CLIP

C007 Mill Finish .024" aluminum

STANDARD PACKAGE: 200 each.

Use with C279 and C280 center bar.

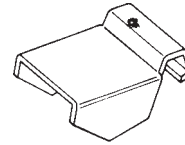

CENTER BAR CLIP

C020 Mill Finish .024" Aluminum

STANDARD PACKAGE: 200 each.

Use with C261 center bar.

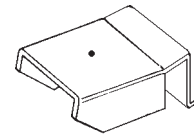

CENTER BAR CLIP

C084 Mill Finish

STANDARD PACKAGE: 200 each.

Use with C284 center bar.

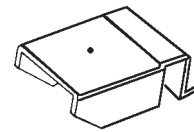

CADMIUM PLATED SPRING

C009 Mill Finish

STANDARD PACKAGE: 100 per package

For half screens. Use T703 drill jig.

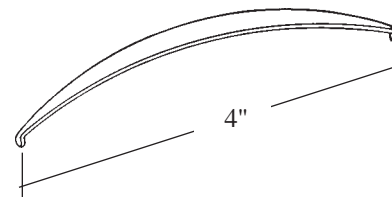

MASON CORPORATION
123 Oxmoor Road, West
Birmingham, AL 35209-6302

Telephone: 1/800/763-4488
Fax: 205/945-4304

SCREEN FRAME - LINEALS & COMPONENTS

SCREEN LIFT

C010 Mill Finish .030" aluminum

STANDARD PACKAGE: 100 per package

Apply in spline groove of half screens.

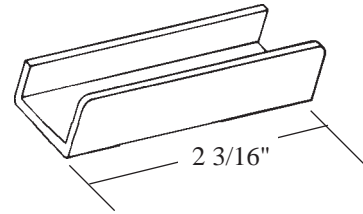

SCREEN LIFT

C011 Mill Finish .030" aluminum

STANDARD PACKAGE: 100 per package

Apply in spline groove of half screens.

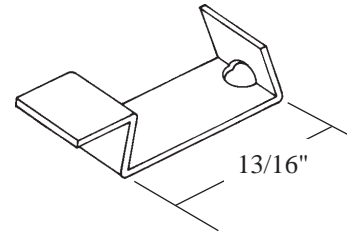

MASON CORPORATION
123 Oxmoor Road, West
Birmingham, AL 35209-6302

Telephone: 1/800/763-4488
Fax: 205/945-4304

SCREEN FRAME - LINEALS & COMPONENTS

STAINLESS STEEL SCREEN COMPONENTS

SCREEN FRAME

C169 Dark Bronze .050" 6063-T5 extruded aluminum
Mill Finish

LENGTH: 16'

Use W302A weatherstripping.

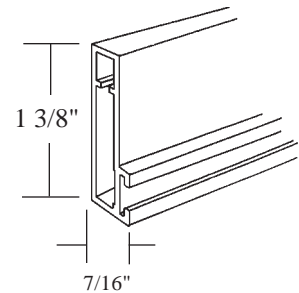

OFFSET SCREEN FRAME

C175 Dark Bronze .050" 6063-T6 extruded aluminum
White

LENGTH: 16'

Use W302A weatherstripping.

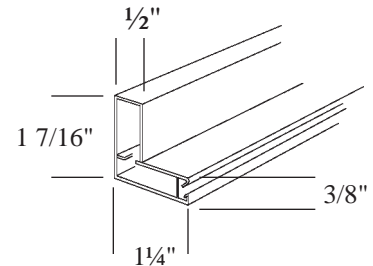

CENTER BAR

C270 Dark Bronze .050" 6063-T5 extruded aluminum
Mill Finish

LENGTH: 16'

Use with C169 security screen frame.

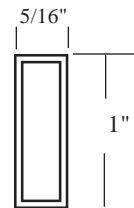

CENTER BAR

C285 Bronze .050" Extruded aluminum
White

STANDARD PACKAGE: As required. 16' lengths.

For use with C175 offset security frame.

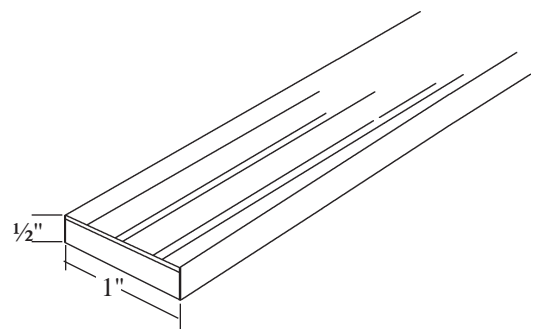

MASON CORPORATION
123 Oxmoor Road, West
Birmingham, AL 35209-6302

Telephone: 1/800/763-4488
Fax: 205/945-4304

SCREEN FRAME - LINEALS & COMPONENTS

STAINLESS STEEL SCREEN COMPONENTS

COVER STRIP

C271 Dark Bronze .062" 6063-T5 extruded aluminum
Mill Finish

LENGTH: 16'

Use with C169 screen frame and C270 center bar
and C175 offset screen frame and C285 center bar.



CORNER INSERT

C470 Mill Finish 6063-T5 extruded aluminum

STANDARD PACKAGE: 100 each per carton

For use with C169 screen frame.

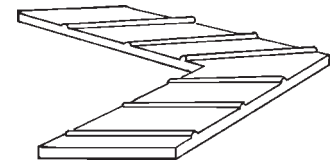

LATCH

C935 Plated Steel 1 1/16" offset

STANDARD PACKAGE: 25 sets per package

Use with C175 offset screen frame.

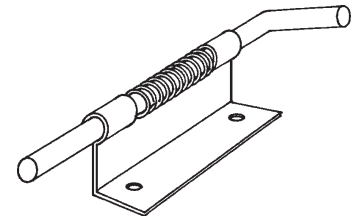

LATCH

C936 Plated Steel Low profile

STANDARD PACKAGE: 25 sets per package

Use with C169 screen frame.

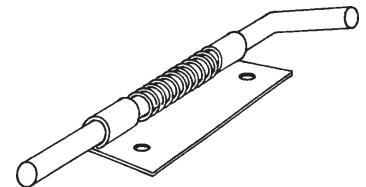

MASON CORPORATION
123 Oxmoor Road, West
Birmingham, AL 35209-6302

Telephone: 1/800/763-4488
Fax: 205/945-4304

SCREEN FRAME - LINEALS & COMPONENTS

STAINLESS STEEL SCREEN COMPONENTS

POP RIVET, 1/8" (Optional)

F451 Dark Bronze Aluminum
 Mill Finish
 White

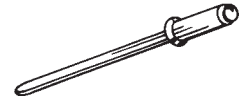

Use to attach cover strip, C271 to C170 frame and C270 center bar. Can also be used to attach hinge.

SCREENING, STAINLESS & CARBON STEEL

G400 #304 stainless steel 12 x 12 mesh
 G500 Black carbon steel 23 gauge electro-galvanized,
 painted black

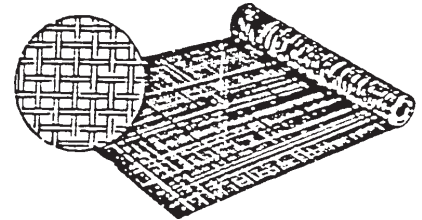

Available in rolls of 36" wide x 100' long.

HINGE, ALUMINUM

E003 Dark Bronze .050" aluminum
 Mill Finish

STANDARD PACKAGE: 72" lengths only

Continuous piano type hinge.

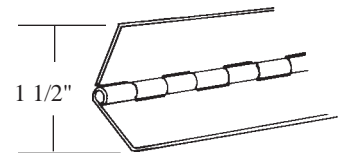

DRILL POINT SCREW

C802 Dark Bronze #6 X 3/8" washer head drill point
 Mill Finish

STANDARD PACKAGE: As required.

Use to fasten C271 to C270 and C170 and C271 to C175 and C285.



MASON CORPORATION
 123 Oxmoor Road, West
 Birmingham, AL 35209-6302

Telephone: 1/800/763-4488
 Fax: 205/945-4304